

**SATURN 1500**

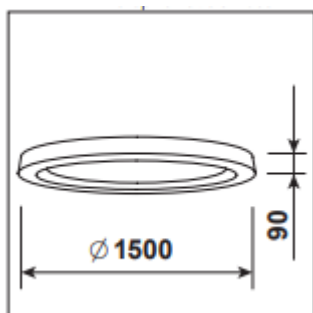

Please see the attached pages for detailed specifications.



<b>Mounting:</b>	Surface mounted or suspended
<b>Body material:</b>	Aluminium profile
<b>Colour:</b>	Standard white RAL 9003S, other RAL colours on request
<b>LED module:</b>	Signify (Philips), Tridonic or equivalent SMD LED modules
<b>Colour temperature:</b>	3000/4000K/2700-6500K TW other on request
<b>Colour Rendering Index (CRI):</b>	CRI>80 in standard, other on request
<b>Driver:</b>	EVG on-off/DALI/TW DT8/MC ( MasterConnect )/Casambi, other on request
<b>Emergency unit:</b>	On request
<b>Movement sensor:</b>	On request
<b>Daylight control sensor:</b>	Built-in XC sensor or wireless MCS sensor
<b>Operating temperature range:</b>	0°C to +35°C
<b>IP Class:</b>	IP20 in standard
<b>Power:</b>	220-240V 50/60Hz
<b>Lighting direction:</b>	Direct/Indirect Lighting
<b>Reflector type:</b>	N/A
<b>Light distribution:</b>	Symmetric
<b>Diffuser:</b>	OP opal acrylic / MP19H microprismatic UGR<19
<b>General data:</b>	5 Years standard warranty, possible extension with project registration Different lumen output or wattage available on request All other technical features such as : Luminaire Eicacy, LOR, Lumen maintenance L/B etc. available in our pricelist Wattage of products may vary due to constant LED eicacy improvements. Luminous lux & Luminaire Power tolerance +/- 10%. System power consumption (LED module & driver) depends on components used