

SATURN 2500

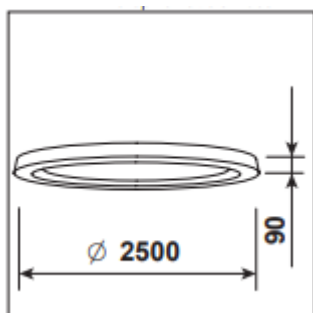

Please see the attached pages for detailed specifications.



Mounting:	Surface mounted or suspended
Body material:	Aluminium profile
Colour:	Standard white RAL 9003S, other RAL colours on request
LED module:	Signify (Philips), Tridonic or equivalent SMD LED modules
Colour temperature:	3000/4000K/2700-6500K TW other on request
Colour Rendering Index (CRI):	CRI>80 in standard, other on request
Driver:	EVG on-off/DALI/TW DT8/MC (MasterConnect)/Casambi, other on request
Emergency unit:	On request
Movement sensor:	On request
Daylight control sensor:	Built-in XC sensor or wireless MCS sensor
Operating temperature range:	0°C to +35°C
IP Class:	IP20 in standard
Power:	220-240V 50/60Hz
Lighting direction:	Direct/Indirect Lighting
Reflector type:	N/A
Light distribution:	Symmetric
Diffuser:	OP opal acrylic / MP19H microprismatic UGR<19
General data:	5 Years standard warranty, possible extension with project registration Different lumen output or wattage available on request All other technical features such as : Luminaire Eicacy, LOR, Lumen maintenance L/B etc. available in our pricelist Wattage of products may vary due to constant LED eicacy improvements. Luminous lux & Luminaire Power tolerance +/- 10%. System power consumption (LED module & driver) depends on components used